



Smart, compact, full-featured OTDR

AQ1210 Series Optical Time Domain Reflectometer

Precision Making

Bulletin AQ1210-01EN



Due to the widespread use of mobile devices and the Internet, the importance of optical fiber networks to accommodate the increasing communication traffic is growing rapidly.

Installation and maintenance of optical fiber networks require a measurement instrument with high productivity and an intuitive interface as well as high quality measurement results and high reliability.

Yokogawa, as a 100+ year instrumentation manufacturer, delivers OTDRs (Optical Time Domain Reflectometer) based on our measurement technologies developed since the early days of optical fiber communication and 39+ years of experience in optical test & measurement solutions for real world lab and field testing.

Responding to the growing needs for reliable and easy-to-use field test instruments for installation and maintenance of fiber optic networks, the Yokogawa AQ1210 series OTDR is designed to empower field technicians to make fast and precise measurements with confidence.

The AQ1210 OTDR delivers:

Reliability – Robust design for operating under harsh field conditions.

Technology – Dual operation mode by multi-touch touchscreen and hard-key buttons. Fully automatic measurement and easy-to-read analysis reports through new software applications.

Operability – Lightning startup time. Multi-tasking operation to enhance productivity. Immediate reporting via wireless connectivity.

Compact body with long hour operation

Footprint approx. size of A5 paper, weight of 1 kg (2.2 Lbs.)
10 hours battery operation

Intuitive operation by touch and hard keys

The AQ1210 features a capacitive multi-touch touchscreen, 5.7-inch LCD, and a “field use” friendly rotary dial.

Connectivity

Data transfer and remote control via Wi-Fi or ETHERNET connection.

Enhanced OTDR performance

Measurement of PON systems with up to 128 splits
Hi-Speed real-time measurement

Functions and features for improved work efficiency

Multi-fiber measurement, Smart mapper function, PDF reporting

Much more than an OTDR

A variety of optional features for multi-tasking.



Multi Field Tester OTDR

AQ1210

Complete testing capabilities in a compact and light package

— Smart, compact, full-featured OTDR —

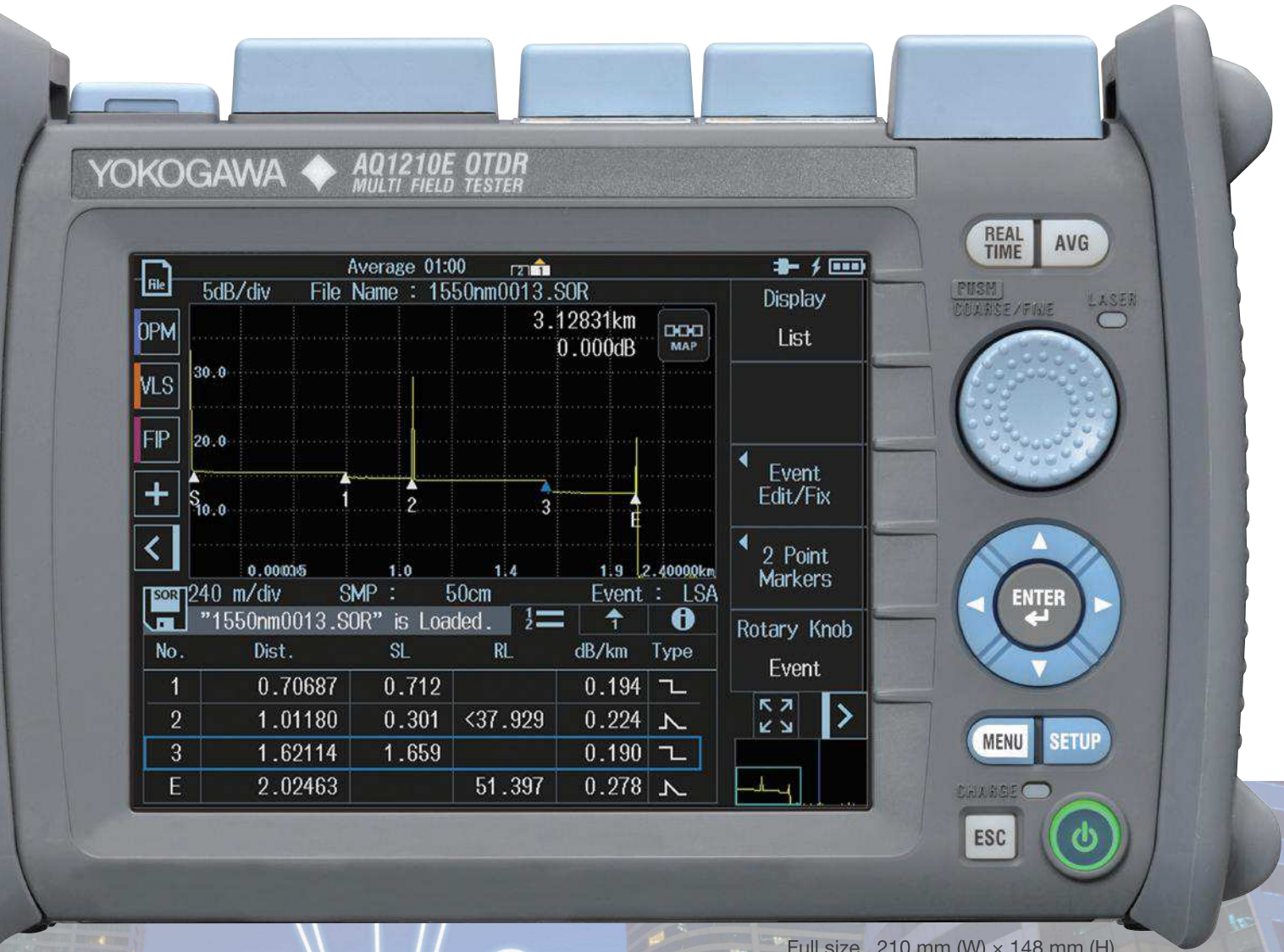

Full size 210 mm (W) x 148 mm (H)

Series



Model lineup & Selection guide

Model lineup

Seven models ideal for installation and maintenance of various optical communication access networks (LAN/PON/FTTA/FTTH/FTTB).

Model	Num. of λ	Num. of ports	Built-in filter	Dynamic range (dB)						Features
				Port 1 (nm)		Port 2 (nm)				
				1310	1550	1625	1650	MM 850	MM 1300	
AQ1210A	2	1		37	35					Standard model equipped with communication service wavelengths.
AQ1215A	2	1		42	40					High dynamic range model equipped with communication service wavelengths.
AQ1210E	3	2	●	37	35	35				Standard model equipped with a port for maintenance wavelength of 1625 nm, which has narrow spectral width and a built-in cut filter for communication service wavelengths.
AQ1215E	3	2	●	42	40	39				High dynamic range model equipped with a port for maintenance wavelength of 1625 nm, which has a built-in cut filter for communication service wavelengths.
AQ1215F	3	2	●	42	40		37			High dynamic range model equipped with a port for maintenance wavelength of 1625 nm, which has narrow spectral width and a built-in cut filter for communication service wavelengths.
AQ1216F	3	2	●	42	40		40			High dynamic range model equipped with a port for maintenance wavelength of 1650 nm, which has a built-in cut filter for communication service wavelengths.
AQ1210D	4	2		37	35			25	27	Access/LAN network model equipped with two ports for single-mode fiber and multimode fiber measurement.

Selection guide

Cable type	Target network			Test application			
	Area		PON	Installation (measurement of new and dark lines)		Installation/Maintenance (measurement of new and live lines)	
				Model	Wavelength (nm)	Model	Wavelength (nm)
Single-mode optical fiber cable	Access	36 dB	1×64	AQ1210A	1310 1550	AQ1210E	1310 1550 1625
	Access/Metro	40 dB	1×128	AQ1215A	1310 1550	AQ1215E	1310 1550 1625
						AQ1215F	1310 1550 1650
						AQ1216F	1310 1550 1650
Multimode optical fiber cable	Access/LAN		1×64	AQ1210D	1310 1550		
			—		850 1300		

Intuitive operation by touch and hard keys

Touchscreen and rotary dial

The AQ1210 features a 5.7-inch multi-touch touchscreen LCD, providing smooth tapping and zooming in/out of traces. In addition, it is equipped with a “field use” friendly rotary dial useful for cursor, marker, and file operations.

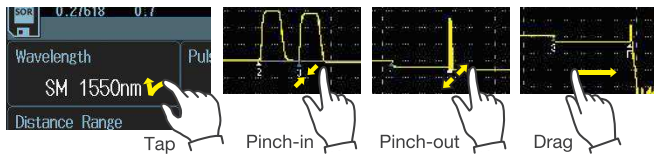

Measurement condition setup window

Measurement conditions can be switched on the OTDR initial screen, which allows efficient measurement of multiple conditions.

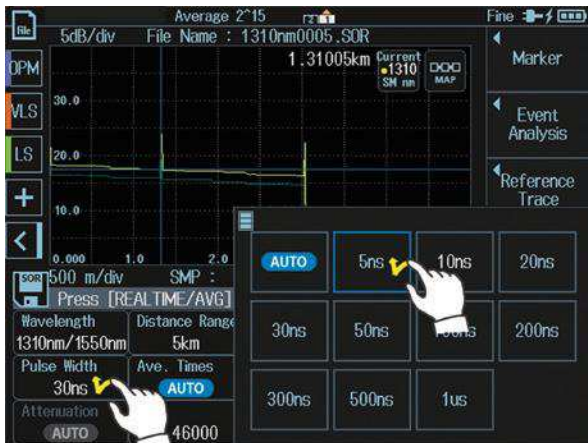

Direct data saving

Simply pressing “Direct save” icon, measured data can be saved in SOR, PDF, or both formats according to users’ prior selection.



Long battery operation time

Over 10 hours!

No worrying about running out of battery power during your daily work. The AQ1210’s high capacity Li-Ion polymer battery will last for 10 hours under the Telcordia standard conditions.



Quick boot-up

Under 10 seconds!

From completely OFF to measurement ready in under 10 seconds!



Enlarging the trace window

By simply tapping the dedicated icon, the trace display window can be enlarged for easy viewing and manipulation. When enlarged, the size of the trace area is about twice the standard size.

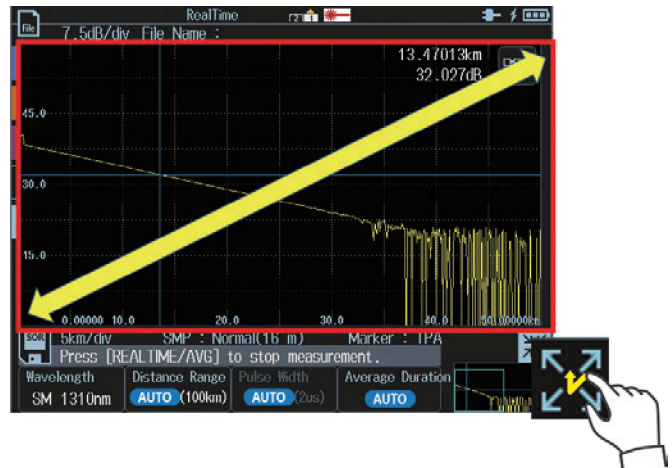

Enhanced OTDR performance

PON optimized

Excellent hardware performance and advanced analysis algorithm enable the AQ1210 to accurately characterize Passive Optical Networks (PON) through high-port-count splitters (up to 1 × 128)*. The AQ1210 assists beginner/expert users in simply configuring OTDR measurement settings based on PON topology information for optimal results. Short event dead zone and high sampling resolution enable users to detect as close as 0.5 meters (<20 inches)*.

*Typical, with AQ1215A/E/F and AQ1216F

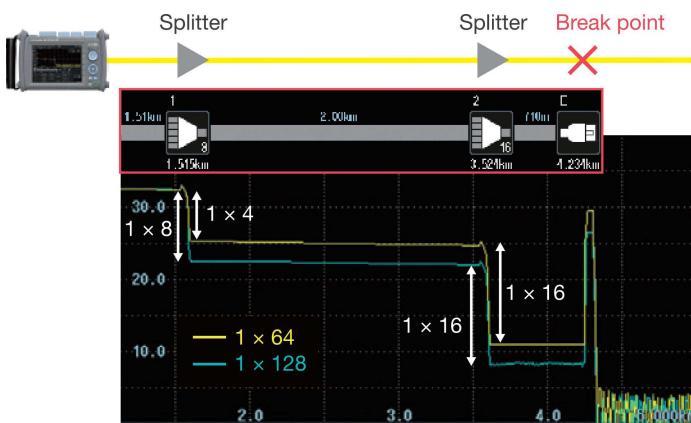

Measurements over a 128 and 64-port splitter

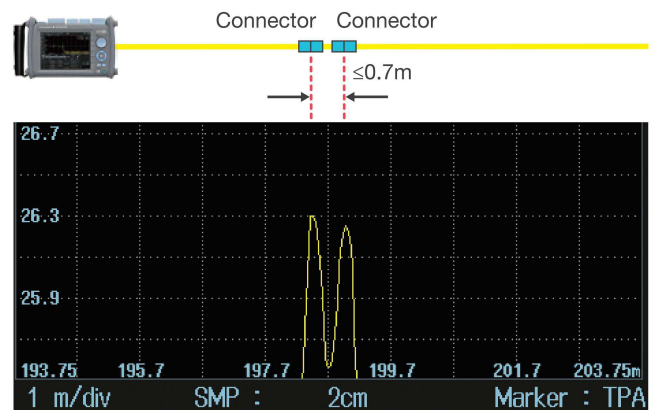

Separation of connections in close proximity

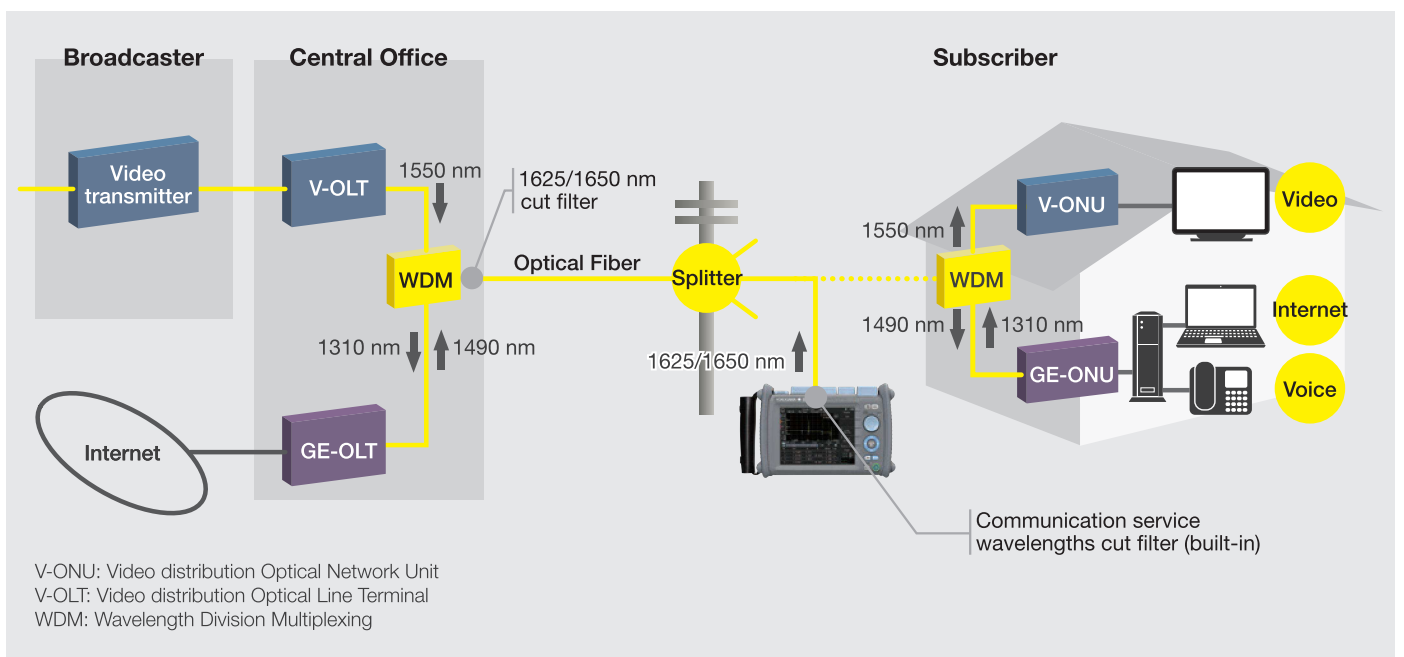

V-ONU: Video distribution Optical Network Unit
 V-OLT: Video distribution Optical Line Terminal
 WDM: Wavelength Division Multiplexing

Real-time measurement

Real-time measurement is a feature that repeats measurement while updating and displaying the measured value. This is useful for detecting/identifying the position of a fiber end point, break, or bend of an installed optical fiber network. Viewing the changes in the trace as an operator change the measurement conditions, such as the wavelength, distance range, and pulse width.

*Real-time measurement is not available in MAP mode.

Hi-Speed real-time

Displays traces at a maximum update rate of 5 times per second. Sudden events such as a bend of optical fiber can be instantly detected.

Hi-Reflection real-time

The quality of display traces is prioritized. Traces are displayed and updated with high precision. The far end of a long-distance fiber that cannot be seen in the Hi-Speed real-time or the points beyond a highly-branched splitter can be measured.

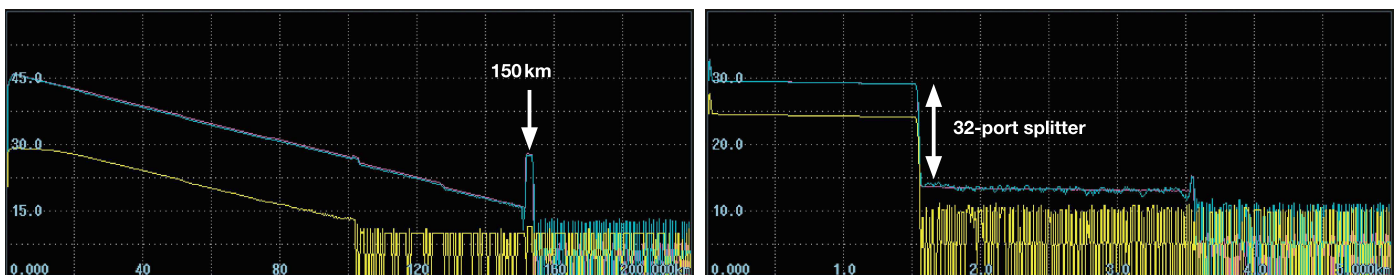

Yellow: Real-time (Hi-Speed), Blue: Real-time (Hi-Reflection), Red: Averaged (Hi-Reflection)

[Noise cut]

This feature is only available in Hi-Speed real time. It reduces noise at the far end point. When measured from the central office above a splitter in the real-time mode, the Fresnel reflection at the far end of split fibers can be clearly determined.

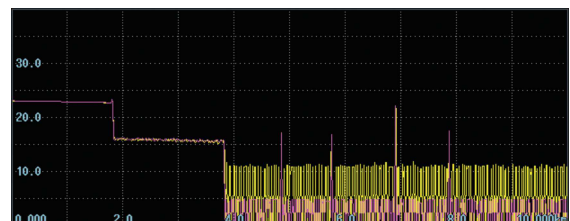

Yellow: Before noise cut Red: After noise cut

[2-location marker]

This feature can be used in real-time for both Hi-Speed and Hi-Reflection. It uses four markers to measure connection loss at two locations simultaneously. This is useful for viewing the loss at each changeover point during rerouting work.

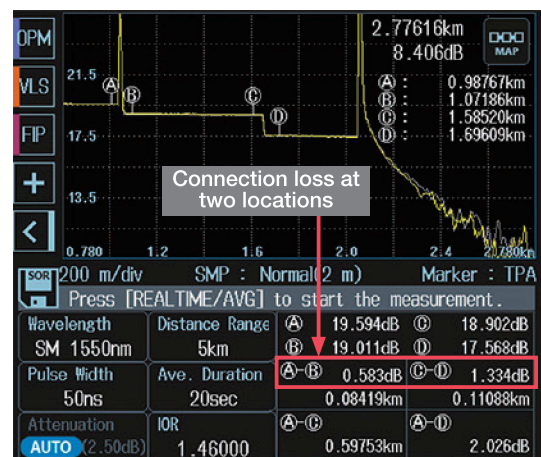
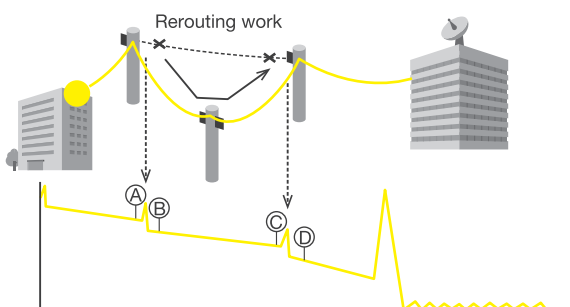

Functions and features for improved work efficiency

Multi-fiber measurement

Measurement conditions of up to 2000 cores are managed in a table, allowing efficient measurement of multi-fibers. For each core number, OTDR measurement, loss measurement and fiber core surface image can be saved. Cores that have been measured are highlighted in color and saved data can be shown in the preview window by selecting the core number in the table. This prevents unintended omission in core measurements and reduces your working time at a site.



Macro bending detector

Macro bending events along a fiber under test can be identified and located automatically by OTDR measurements using multiple wavelengths trace comparison and event analysis based on user-defined thresholds.



PDF reporting

Built-in post-processing software for generating OTDR reports in PDF format. Flexible configuration of report template to meet users' report requirements. The report format is set while checking the layout preview and collectively create a plurality of reports.



Advanced trace analysis

Menu	Type	Evaluation target
Trace analysis	Multi-trace analysis	Multi-fiber cables
	2-way trace analysis	Optical fiber link which consists of different types of fibers.
	Differential trace analysis	Aged deterioration of fibers
OTDR	Section analysis	Total return loss of a certain section.

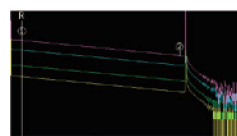

Multi-trace analysis

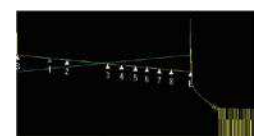

2-way trace analysis

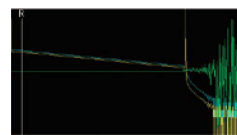

Differential trace analysis

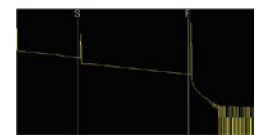

Section analysis

Work completion notice

The instrument notifies you of the completion of splice work of optical fibers with a message on the screen and an alarm sound. You don't need to keep looking at the screen, so that you use your time effectively by doing other work.

Smart mapper

Measurement acquisitions with multiple pulse widths and smart-algorithm enable users to detect and comprehensively characterize network events by pressing one single button. Simple, icon-based map view for easy interpretation of the location and type of events, so even beginners can understand complex network configurations. Immediate PASS/FAIL judgment based on user-defined thresholds.

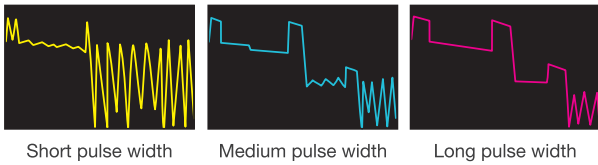
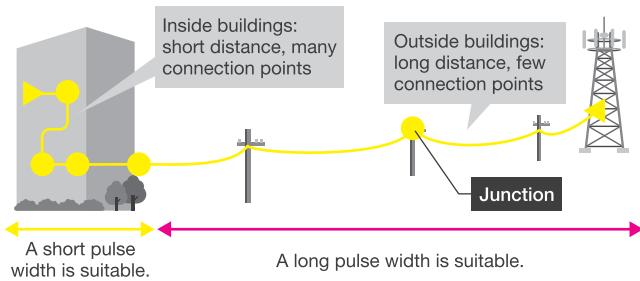

Takes certain parts of the measured traces, links trace together.

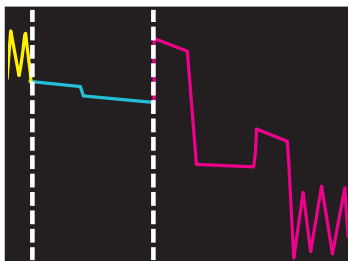

Event analysis

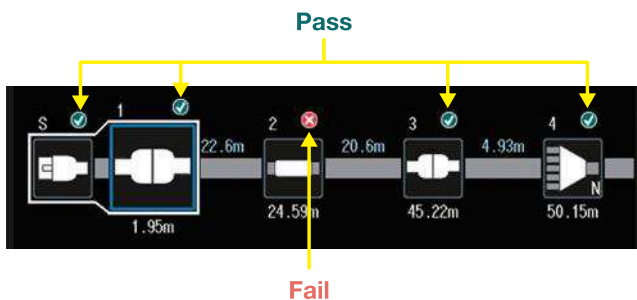

Event icon

The appropriate icon will be displayed from 5 different event icons.

PASS/FAIL judgment results can be easily recognized by the "✓" and "x" marks and colors.

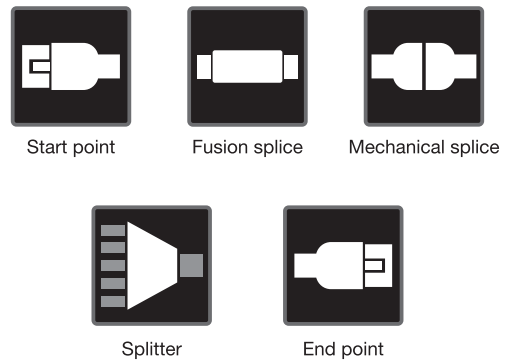

Easily toggled trace view

The view can be switched between the map and the trace by simply tapping the icon.

The number of steps of the splitter is also displayed, making it even easier to understand. The trace display shows the pulse width used for PASS/FAIL judgment all at once on one screen.

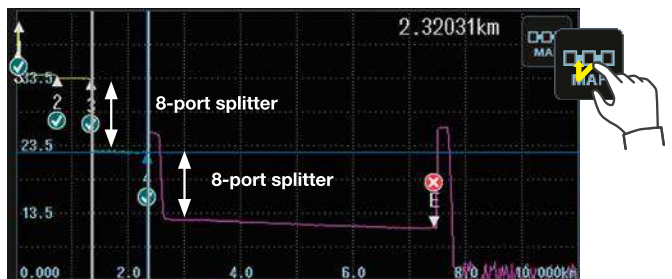

Yellow: Trace with a pulse width of 10 ns
Blue: Trace with a pulse width of 50 ns
Red: Trace with a pulse width of 2 μs

Much more than an OTDR

Measurement functions required for optical fiber installation, replacement and maintenance can be installed on the OTDR. They are available for single-tasking and multi-tasking.

Light source (standard feature)



Light source feature using the OTDR port. It can modulate and output light at the OTDR wavelength and be used for measuring optical loss or as a light source for optical fiber identification.

Visible light source (option)



Visible, continuous/modulated red light laser. Invaluable test instrument for checking continuity of patch cords, launch fibers, or short fiber trunks. Breaks and bends in the fiber can easily be identified visually as the visible light exits the fiber at such fault events.

*VLS option is required.

Power checker (option) (Integrated optical power meter)



Power Checker is a basic optical power meter integrated into the OTDR port. It is useful when checking the optical power before making an OTDR measurement. Because it uses the same port as the OTDR, it does not require to switch the ports.

*/PC option is required. Only port 1 supports this feature.

*850/1300 nm are not supported.

Optical power meter (option)



There are three types of optical power meter, standard, high power, and PON.

The standard and high power models support a wide range of applications, such as wavelength setting in 1 nm increments, modulation signal measurement, and multi-fiber measurement. The PON model can measure the optical power both at 1490 nm and at 1550 nm simultaneously by separating those wavelengths.

The optical power meter port is a dedicated port, so it can be used with the light source, which is a standard feature, for loss measurement.

*/SPM, /HPM, or /PPM option is required.

Fiber inspection probe

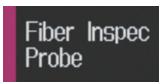

Fiber surface image display (standard feature)

Using a video fiber inspection probe*, fiber connector surface is visualized for inspection of scratches and dirt.

*Recommended probe: DI-1000-B2/DI-2000-B2 (Lightel), FVO-730B-P (Eternal)

Fiber surface test function (option)

This function can automatically analyze scratches and dirt and makes PASS/FAIL judgment based on IEC61300-3-35 compatible or arbitrary decision criteria. The surface image can be saved and the judgment results can be output to a PDF report.

*/FST option and a recommended optical fiber scope are required.

*This function cannot be used for multi-tasking.

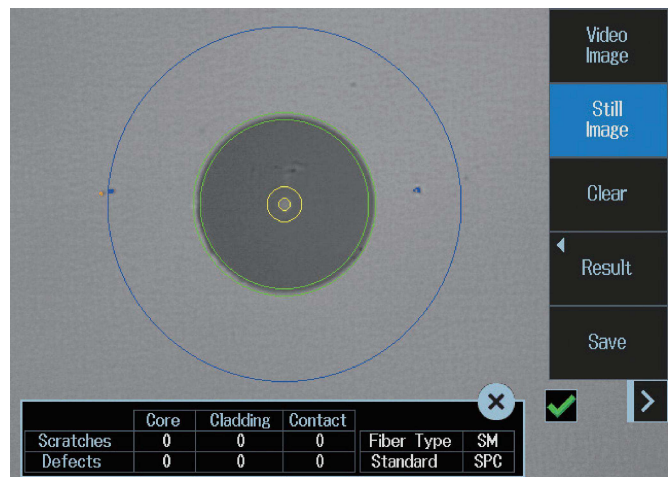

Multi-tasking

While the OTDR measurement is in progress, other functions such as optical power meter, visible light source, and optical fiber inspection probe can also be used at the same time. This unique multi-tasking feature reduces “idle time” during the measurements and contributes to improved work efficiency.

For example, checking the surface of or measure the optical power of one fiber while measuring another fiber with OTDR function. However, the OTDR, stabilized light source and power checker functions cannot be used simultaneously because these share the same port.

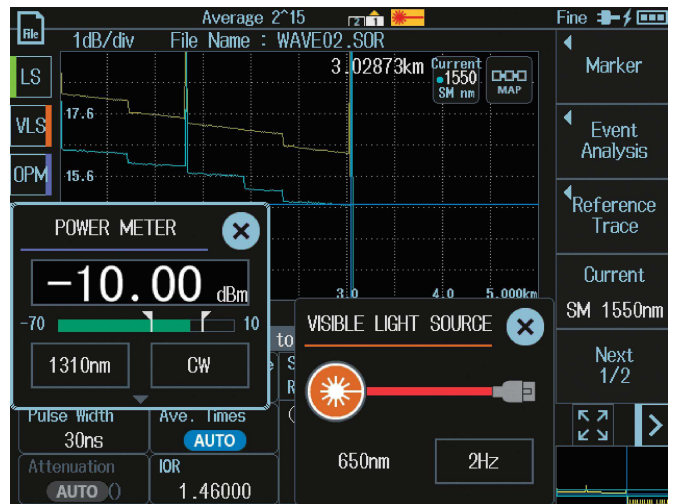

Example of multi-tasking with OTDR, optical power meter, and visible light source

Loss test

Use the light source and optical power meter to measure optical loss.*1

High power measurement

The high power optical power meter can measure video services, such as CATV, and long distance transmission lines where an optical amplifier is used to boost the optical signal power.

Auto loss test function*2

The AQ1210 can transmit the wavelength information of light source to the other AQ1210 placed at the other end to set the same wavelength for the optical power meter, and they are capable of switching the wavelengths automatically; therefore, the loss measurements can always be performed at right wavelengths.

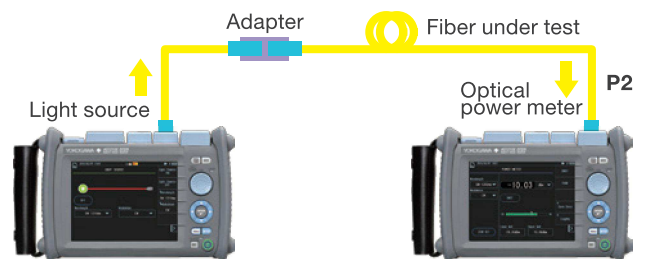

Multi-fiber loss test*2

The Multi-fiber loss test function incorporates two AQ1210s as master and slave through the communication fiber in the cable under test. They share a test project information including fiber numbers to be tested and measurement conditions, so it can be ensured the measurement is performed properly for each fiber of the cable under test.

*1: /SPM or /HPM option is required.

*2: AQ1210, AQ1200, and AQ1100 with /SPM or /HPM option can be used.

Connectivity

By connecting the instrument to an external device (PC, mobile device) via USB cable or wired/wireless LAN adapter, easily perform file transfer and remote control using a web browser or application software.

USB cable

Direct connection to a PC with a USB cable (Type-C).
Use the remote controller feature of AQ7933 Emulation software for easy connection. This is useful for controlling the OTDR while doing other work on a PC.

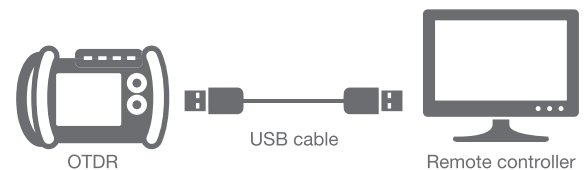

Wired LAN

Connection to an external device or networks via wired LAN adapter^{*1}.
For example, an engineer can add an OTDR to the company's local network. This is useful for regularly checking the measurement status on an OTDR performing continuous measurement at a distant place. If an engineer is in an environment that allows connection to the company's internal network from the outside, an engineer can check the OTDR measurement status regardless of an engineer's location.

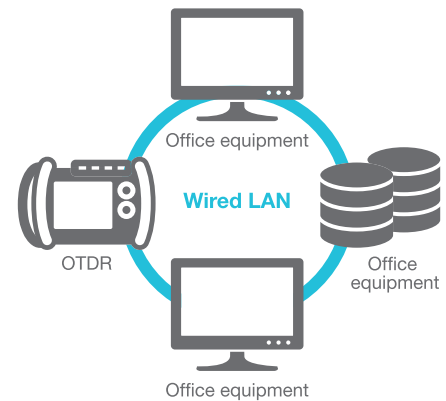

Wireless LAN

Connection to an external device via wireless LAN adapter^{*2}.
This provides you high portability.
The AQ1210 can be controlled and internal data can be retrieved by an external device without cable connection.

Remote control via the public network is possible by using a wireless LAN adapter^{*2} and mobile router^{*3}.
An engineer goes to a work site with an OTDR and mobile router^{*3} and an operator who is working at the office or from home can check the engineer's work details.

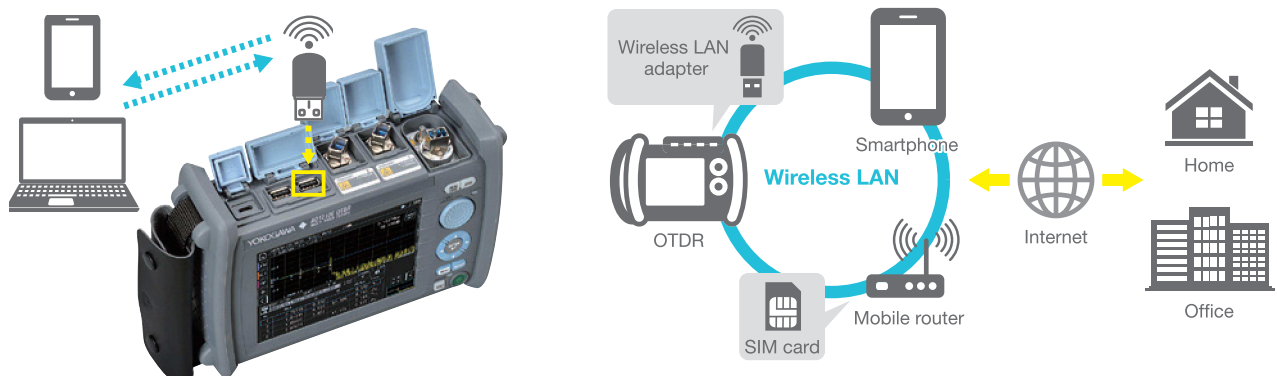

*1 Commercial wired LAN adapter (verified: UE300 (TP-Link))

*2 Commercial wireless LAN adapter (verified: TL-WN725N (TP-Link), CF-WU810N (COMFAST))
Wireless LAN supports only 2.4GHz.

*3 The port forwarding function of mobile router is used. R1.03 or later firmware

Web browser

The AQ1210 series have a web server feature, so file transfer and remote control are possible using a web browser on an external device without worrying about the OS of the external device.

Just enter the IP address of an OTDR, and the OTDR's screen will be replicated on the web browser on external device. Performing the same operations as those of the OTDR main unit and download measurement data saved in the OTDR.

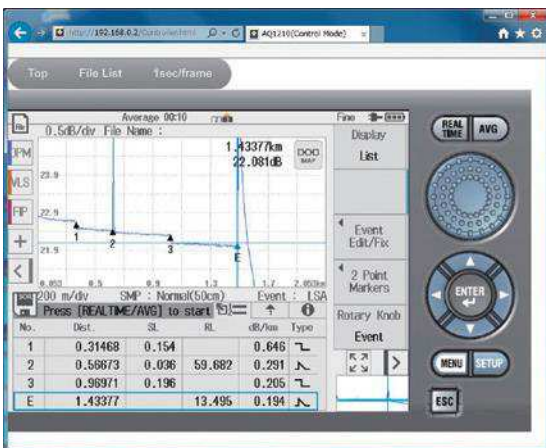

Data transporter

Application software for mobile device (iOS and Android) that enables data transfer between an OTDR and a mobile device.

By using the data transporter, the AQ1210's data files are able to be saved to cloud storage or be attached to an email by a mobile device connected to the AQ1210 with wireless LAN. Simple analysis of loaded trace data is also possible.

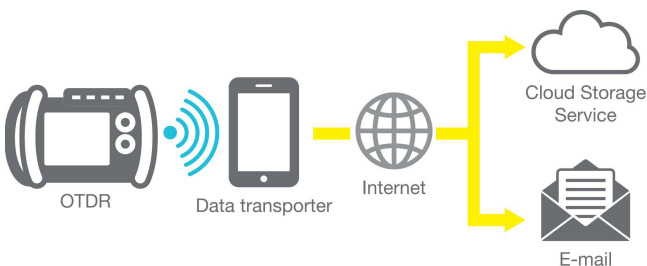

AQ7933 Emulation software

Software to display and analyze the trace data measured on an OTDR. It can also create and output reports of analysis results on a PC. Equipped with the remote controller and file transfer applications, this is a more powerful tool to assist your work.

Collective event analysis

Up to 1000 traces can be loaded. (SOR) It has the function to set events or markers on all loaded traces collectively.

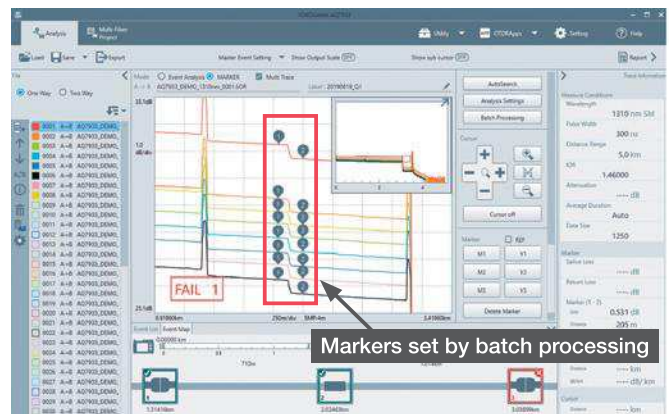

Report creation

Just click the Report button when an analysis is completed, then a report will be created instantly. The report layout is easily modified by selecting parts on the graphical parts panel.

The AQ7933 can be downloaded from the YMI website. Some features are free to use. Windows 7 or later is supported.

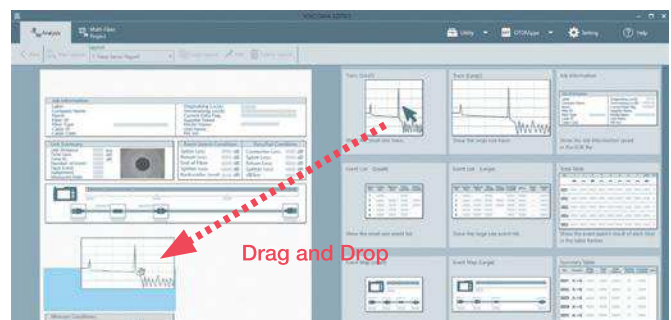

Specifications

OTDR

Items		Specifications						
Model		AQ1210A	AQ1215A	AQ1210E	AQ1215E	AQ1215F	AQ1216F	AQ1210D
Wavelength (nm) ¹		1310 ±20/1550 ±20		1310 ±20/ 1550 ±20, 1625 ±10	1310 ±20/ 1550 ±20, 1625 ±20	1310 ±20/ 1550 ±20, 1650 ±5 ⁶	1310 ±20/ 1550 ±20, 1650 ±20	1310 ±20/1550 ±20, 850 ±15/1300 ±30
Number of optical ports		1		2 (Port 2: 1625 nm, including a filter)		2 (Port 2: 1650 nm, including a filter)		2 (Port 2: 850/1300 nm)
Applicable fiber		SM (ITU-T G.652) (1310/1550/1625/1650 nm), GI (50/125 μm) and GI (62.5/125 μm) (850/1300 nm)						
Distance range (km)		0.1 to 256	0.1 to 512	0.1 to 256	0.1 to 512		0.1 to 256, 0.1 to 100	
Pulse width (ns)		5 to 20000	3 to 20000	5 to 20000	3 to 20000		5 to 20000, 3 to 1000/3 to 5000	
Event dead zone (m) ^{1,7,8}		0.75	0.5	0.75	0.5		0.75, 0.5	
Attenuation dead zone (m) ^{2,8}		4	2.5	4	2.5		4, 2.5	
PON dead zone (m) ^{3,8}		35	30	35	30		35, —	
Dynamic range (dB) ^{4,8}		37/35	42/40	37/35, 35	42/40, 39	42/40, 37	42/40, 40	37/35, 25/27
Loss measurement accuracy ⁵		±0.05 dB/dB	±0.03 dB/dB	±0.05 dB/dB	±0.03 dB/dB		±0.05 dB/dB	
Optical return loss measurement accuracy		±2 dB						
Maximum optical pulse output power		—	—	—	—	≤+15 dBm (1650 nm)	—	—
Number of sampling points		max. 256000						
Sampling resolution		min. 5 cm	min. 2 cm	min. 5 cm	min. 2 cm		min. 5, 2 cm	
Minimum readout resolution		Horizontal axis: 1 cm, vertical axis: 0.001 dB						
Distance unit		m, km, mile, kft						
Distance measurement accuracy		± (0.75 m + measured distance × 2 × 10 ⁻⁵ + sampling resolution)						
Group refractive index		1.30000 to 1.79999 (0.00001 intervals)						
Optical connector		SC/FC/LC/SC Angled-PC (1310/1550/1625/1650 nm), SC/FC/LC (850/1300 nm)						
OTDR function	Measurement items	Distance, loss, return loss, return loss between two arbitrary points, dB/km						
	Analysis	Multi-trace, 2-way trace, differential trace, section analysis, auto event search, pass/fail judgment, fiber surface test (option)						
	Other functions	Multi-fiber project, rerouted fiber comparison, work completion notice, smart mapper, remote control, web server, report generation, plug check, fiber-in-use alarm						
Light source function	Output power	-3 dBm ± 1 dB (1310/1550/1625/1650 nm), ≥-20 dBm (850/1300 nm)						
	Output power stability ⁷	±0.05 dB (1310/1550 nm), ±0.15 dB (1625/1650/850/1300 nm)						
	Modulation mode	CW, 270 Hz, 1 kHz, 2 kHz (1310/1550/1625/1650 nm), CW, 270 Hz (850/1300 nm)						
	Optical output port	OTDR port						
Laser class		Class 1M (EN 60825-1: 2007, GB 7247.1-2012), Class 1 (EN 60825-1: 2014) (1300/1310/1550/1625/1650 nm), Class 3R (IEC 60825-1:2007, GB 7247.1-2012, EN 60825-1:2014) (850 nm)						
Display ⁹		5.7-inch color TFT LCD (resolution: 640 × 480, multi-touch capacitive touchscreen)						
Interfaces		USB 2.0 type-A × 2: USB mass storage device, fiber inspection probe, wired LAN adapter, wireless LAN adapter USB 2.0 type-C × 1: DC power supply, storage, remote control						
Data storage	Storage	Internal: ≥1000 traces, external: USB storage						
	File format	Write: SOR, CSV, SET, SMP, BMP, JPG, report Read: SOR, SET, SMP						
Power requirements ¹⁰		USB power supply (Type-C), DC 5 V ±5%, max. 3 A						
Battery ⁸		Type: Lithium ion polymer Operation time: 10 hours or more (Telcordia GR-196-CORE Issue 2, September 2010), Recharge time: 5 hours (power-off state)						
Environmental conditions		Operating temperature: -10 to 50°C (10 to 35°C when charging the battery), operating humidity: 5 to 90%RH (non-condensing), storage temperature: -20 to 60°C, storage humidity: 0 to 90%RH (non-condensing), altitude: 4000 m, dust and drip protection: IP51 equivalent ¹²						
EMC ¹¹	Emission	EN 61326-1 Class A, EN 55011 Class A Group1						
	Immunity	EN 61326-1 Table2						
Laser safety standard ¹¹		EN 60825-1: 2014, IEC 60825-1: 2007, GB 7247.1-2012, FDA 21CFR1040.10 and 1040.11						
Environmental regulation standard		EN 50581						
Dimensions		Approx. 210 mm (W) × 148 mm (H) × 69 mm (D) (excluding projections)						
Weight		Approx. 1 kg (including battery)						

¹: Minimum pulse width, return loss: ≥55 dB (≥40 dB for 850/1300 nm), group refractive index: 1.5, at 1.5 dB below the unsaturated peak level.

²: Pulse width: 10 ns, group refractive index: 1.5, at a point where the backscatter level is within ±0.5 dB of the normal level. For SMF, at 1310 nm, return loss: ≥55 dB. For MMF, at 850 nm, return loss: ≥40 dB.

³: Pulse width: 100 ns (AQ1210A/AQ1210E/AQ1210D), 50 ns (AQ1215A/AQ1215E/AQ1215F/AQ1216F), at 1310 nm, for non-reflective fiber with a loss of 13 dB, 850/1300 nm are not supported.

⁴: Pulse width: 20000 ns, measurement time: 3 minutes, SNR = 1, decrease by 0.5 dB with an angled-PC connector. For MMF 850/1300 nm, pulse width: 500 ns (850 nm)/1000 ns (1300 nm), measurement time: 3 minutes, SNR = 1, GI60.

⁵: ±0.05 dB for a loss of 1 dB or less.

⁶: At 20 dB below the spectral peak of pulsed optical output, at 23°C, after 30 minutes warm up.

⁷: Constant temperature, for 5 minutes after 5 minutes warm up.

⁸: Typical.

⁹: The LCD may contain some pixels that are always on or off (0.002% or fewer of all displayed pixels including RGB), but this is not indicative of a general malfunction.

¹⁰: Require approx. 3 amperes for recharging during operation, approx. 2 amperes for recharging in power-off state.

¹¹: With Optical power meter and Visible light source option

¹²: All the lids are being closed.

Optical Power Meter (/SPM, /HPM, /PPM) and Power Checker (integrated optical power meter) (/PC)

Items		Specifications			
Model		Standard (/SPM)	High Power (/HPM)	PON (/PPM)	Power Checker (/PC) ^{*3}
Wavelength setting		800 to 1700 nm	800 to 1700 nm	1310/1490/1550 nm	1310/1490/1550/1625/1650 nm
Power range	CW	-70 to +10 dBm	-50 to +27 dBm ^{*1}	-70 to +10 dBm (1310/1490 nm) -50 to +27 dBm (1550 nm)	-50 to -5 dBm ^{*4}
	CHOP	-70 to +7 dBm	-50 to +24 dBm ^{*1}	—	—
Noise level		0.5 nW (-63 dBm, 1310 nm)	50 nW (-43 dBm, 1310 nm)	0.5 nW (-63 dBm, 1310 nm) 50 nW (-43 dBm, 1550 nm)	—
Uncertainty ^{*2}		≤±5%			±0.5 dB ^{*5}
Applicable fiber		SM (ITU-T G.652), GI (50/125 μm)		SM (ITU-T G.652)	
Readout resolution		0.01 dB			
Level unit		Absolute: dBm, mW, μW, nW, relative: dB			
Modulation mode		CW, 270 Hz, 1 kHz, 2 kHz			
Averaging		1, 10, 50, 100 times			
Data save		100 data per file (up to 1000 files)			
Data logging		Logging intervals: 0.5, 1, 2, 5, 10 s, number of data: 10 to 1000			
Optical connector		SC, FC, 2.5 mm diameter ferrule, 1.25 mm diameter ferrule			
Functions		Auto loss test, multi-fiber loss test		—	

*1: 1300 to 1600 nm
 *2: CW, 1310 ±2 nm (Standard, High Power, PON at 1310), 1550 ±2 nm (PON at 1550 nm), spectral width: 10 nm or less, input power: 100 μW (-10 dBm), SM (ITU-T G.652), FC/PC connector, wavelength setting: measured wavelength ±0.5 nm, excluding a secular change of equipment (add 1% a year after calibration)
 *3: OTDR Port 1, not applicable to Port 2
 *4: CW, maximum input power: 0 dBm (1 mW)
 *5: CW, 1310 ±2 nm, spectral width: 10 nm or less, input power: 100 μW (-10 dBm), SM (ITU-T G.652), FC/PC connector, wavelength setting: measured wavelength ±0.5 nm, excluding a secular change of equipment (add 1% a year after calibration)

Visible Light Source (VLS)

Items	Specifications
Wavelength	650 ±20 nm
Optical output power	-3 dBm or more (Peak)
Modulation mode	CW, CHOP (Approx. 2 Hz)
Optical connector	2.5 mm diameter ferrule type
Laser class	Class 3R (IEC 60825-1: 2007, EN 60825-1: 2014, GB 7247.1-2012)

Note. All the specifications are valid at 23°C ±2°C and after a warming up for 30 minutes or more, unless otherwise stated.



VLS



Complies with 21 CFR 1040.10 and 1040.11 except for deviations pursuant to Laser Notice No.50, dated June 24, 2007 2-9-32 Nakako, Musashino-shi, Tokyo 180-8750, Japan

OTDR



OTDR (850 nm)

Design

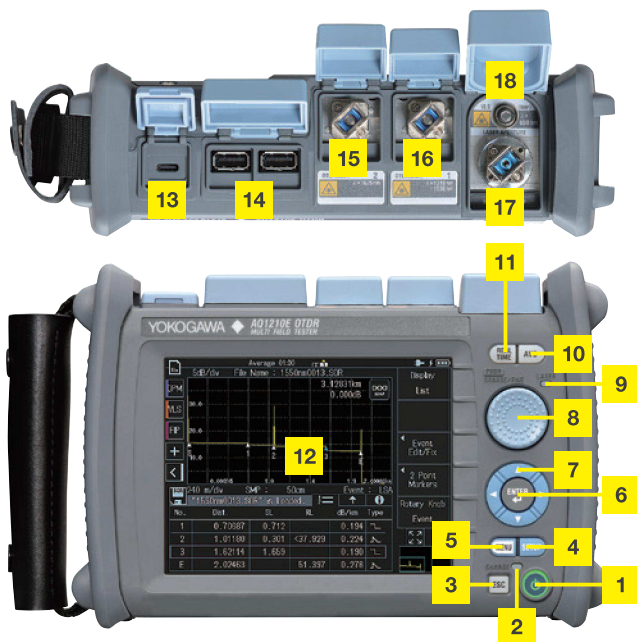

- 1 Power switch
- 2 CHARGE LED
- 3 ESC Key
- 4 SETUP Key
- 5 MENU Key
- 6 ENTER Key
- 7 Allow Key
- 8 Rotary dial
- 9 LASER LED
- 10 AVG Key
- 11 REAL TIME Key
- 12 LCD
- 13 USB port Type-C
- 14 USB port Type-A
- 15 OTDR port (Port 2)
- 16 OTDR port (Port 1)
- 17 OPM port (option)
- 18 VLS port (option)

Model and suffix code

Model	Suffix	Descriptions
AQ1210A		2WL 1310/1550 nm 37/35 dB
AQ1215A		2WL 1310/1550 nm 42/40 dB
AQ1210E		3WL 1310/1550, 1625 nm 37/35, 35 dB ^{*1}
AQ1215E		3WL 1310/1550, 1625 nm 42/40, 39 dB ^{*1}
AQ1215F		3WL 1310/1550, 1650 nm 42/40, 37 dB ^{*1}
AQ1216F		3WL 1310/1550, 1650 nm 42/40, 40 dB ^{*1}
AQ1210D		4WL 1310/1550, 850/1300 nm 37/35, 25/27 dB
Language	-HE	English (Multi-language)
	-HM	Chinese
	-HC	Chinese/English
	-HK	Korean/English
	-HR	Russian/English
Optical connector	-USC	Universal adapter (SC)
	-UFC	Universal adapter (FC)
	-ULC	Universal adapter (LC)
	-ASC	Universal adapter (SC Angled-PC) ^{*2}
Options	Optical Power Meter (OPM) ^{*3}	/SPM Standard optical power meter /HPM High power optical power meter /PPM PON optical power meter
	Power Checker ^{*3}	/PC Integrated optical power meter
	Visible Light Source ^{*3}	/VLS Optical connector: 2.5 mm diameter ferrule type
	Fiber Surface Test function	/FST Pass/fail judgment
	Shoulder Belt	/SB

Standard accessories: Connecting cable for USB power adapter, hand belt, start-up guide

*1: The OTDR port for 1625 or 1650 nm is equipped with a built-in filter.

*2: When -ASC is selected, OTDR port is SC Angled-PC connector and OPM port is SC connector. As for optional accessories, only -ASC of 735482 can be selected for OTDR port, and any type of 735480 and 735481 can be selected for OPM port.

For the AQ1210D, when -ASC is selected OTDR port 1 (SM) is -ASC, and OTDR port 2 (MM) is -USC. There is no option to select -ASC for OTDR port 2 (MM).

*3: The options cannot be added after shipping.

Yokogawa's approach to preserving the global environment

- Yokogawa's electrical products are developed and produced in facilities that have received ISO14001 approval.
- In order to protect the global environment, Yokogawa's electrical products are designed in accordance with Yokogawa's Environmentally Friendly Product Design Guidelines and Product Design Assessment Criteria.

This is a Class A instrument based on Emission standards EN61326-1 and EN55011, and is designed for an industrial environment.

Operation of this equipment in a residential area may cause radio interference, in which case users will be responsible for any interference which they cause.

- Any company's names and product names mentioned in this document are trade names, trademarks or registered trademarks of their respective companies.

NOTICE

- Before operating the product, read the user's manual thoroughly for proper and safe operation.

"Typical" or "Typ." in this document means "Typical value", which is for reference, not guaranteed specification.



Accessories (sold separately)

Model	Suffix	Descriptions
AQ7933		AQ7933 Emulation Software
	-SP01	Download version (1-license)
	-SC01	Package version (1-license with CD)
735051		Additional Option License
	-FST	Fiber Surface Test function
735482		Universal Adapter (for OTDR)
	-SCC	SC type
	-FCC	FC type
	-LCC	LC type
	-ASC	SC Angled-PC type
735480		Connector Adapter (for OPM)*
	-SCC	SC type
	-FCC	FC type
735481		Ferrule Adapter (for OPM)*
	-SFC	2.5 mm diameter ferrule type
	-LMC	1.25 mm diameter ferrule type
739884		Battery Pack
A1681WL		USB Cable (Type-C to Type-C)
B8070CY		Shoulder Belt
SU2006A		Soft Carrying Case

*APC compatible

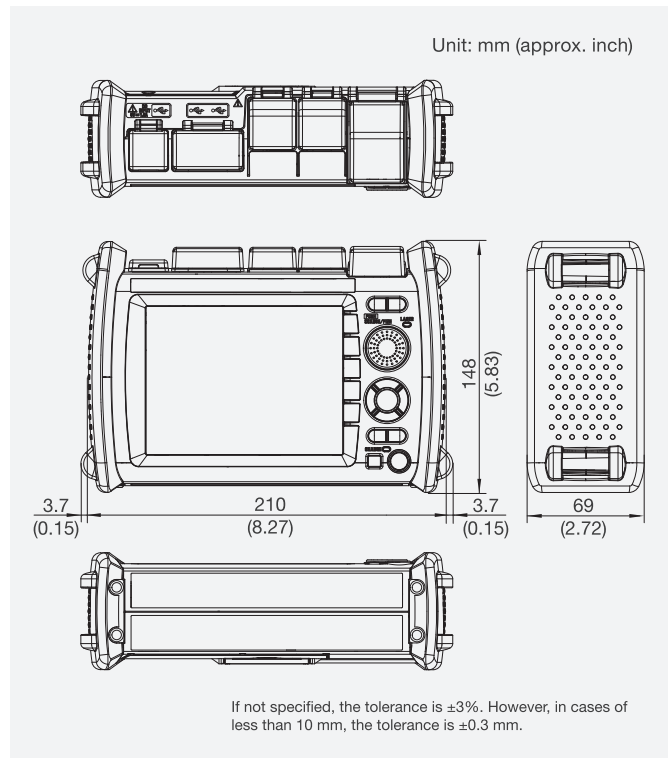

YOKOGAWA

<https://tmi.yokogawa.com/>

YMI-KS-MI-SE07

YOKOGAWA TEST & MEASUREMENT CORPORATION

Global Sales Dept. /Phone: +81-422-52-6237 E-mail: tm@cs.jp.yokogawa.com

Facsimile: +81-422-52-6462

YOKOGAWA CORPORATION OF AMERICA

YOKOGAWA EUROPE B.V.

YOKOGAWA TEST & MEASUREMENT (SHANGHAI) CO., LTD.

YOKOGAWA ELECTRIC KOREA CO., LTD.

YOKOGAWA ENGINEERING ASIA PTE. LTD.

YOKOGAWA INDIA LTD.

YOKOGAWA ELECTRIC CIS LTD.

YOKOGAWA AMERICA DO SUL LTDA.

YOKOGAWA MIDDLE EAST & AFRICA B.S.C(c)

Phone: +1-800-888-6400

Phone: +31-88-4641429

Phone: +86-21-6239-6363

Phone: +82-2-2628-3810

Phone: +65-6241-9933

Phone: +91-80-4158-6396

Phone: +7-495-737-78-68

Phone: +55-11-3513-1300

Phone: +973-17-358100

E-mail: tmi@us.yokogawa.com

E-mail: tmi@nl.yokogawa.com

E-mail: tmi@cs.cn.yokogawa.com

E-mail: TMI@kr.yokogawa.com

E-mail: TMI@sg.yokogawa.com

E-mail: tmi@in.yokogawa.com

E-mail: info@ru.yokogawa.com

E-mail: tm@br.yokogawa.com

E-mail: help.ymatmi@bh.yokogawa.com

Facsimile: +86-21-6880-4987

Facsimile: +82-2-2628-3899

Facsimile: +65-6241-9919

Facsimile: +91-80-2852-1442

Facsimile: +7-495-737-78-69

Facsimile: +973-17-336100

The contents in this catalog is as of September 2020. Subject to change without notice.

Copyright © 2019, Yokogawa Test & Measurement Corporation

[Ed: 02/b]

Printed in Japan, 009(KP)